

English

183  
IO**Metal Frame Pool with Canopy 6'x15" (183cm x 38cm)****IMPORTANT SAFETY RULES**

**Read and follow all safety information and instructions. Keep for future reference. Failure to follow these warnings and instructions can result in serious injury or death to users, especially children.**

Packaging must be read carefully and kept for future reference.

See product for additional warnings.

**WARNING**

- Never leave your child unattended – drowning hazard.
- Only for domestic use. Only for outdoor use.
- Recommended user age: 3 years and above.
- Children, especially children younger than 5 years, are at high risk of drowning.
- Children can drown in very small amounts of water. Empty the pool when not in use.
- Keep children in your direct sight, stay close, and actively supervise them when they are in or near the pool and when you are filling and emptying the pool. When searching for a missing child, check the pool first, even if child is thought to be in the house.
- Empty pool completely after each use and store the empty pool in such a way that it does not collect water from rain or any other source.
- Keep unsupervised children from accessing the pool by installing fencing or other approved barrier around all sides of pool. State or local laws or codes may require fencing or other approved barriers. Check state or local laws and codes before setting up pool.
- Do not leave toys inside pool when finished using, since toys and similar items might attract a child to the pool.
- Position furniture (for example, tables, chairs) away from pool and so that children cannot climb on it to gain access to the pool.
- Do not dive or jump into this pool. Diving or jumping into shallow water can result in broken neck, paralysis, or death.
- Keep all electrical lines, radios, speakers and other electrical appliances away from the pool. Do not place pool near or under overhead electrical lines.
- Keep a working phone and a list of emergency numbers near the pool.
- Become certified in cardiopulmonary resuscitation (CPR). In the event of an emergency, immediate use of CPR can make a life-saving difference.
- Assemble and disassemble by adults only. Never attempt to remove the canopy while in the pool.
- Remove canopy and store properly when not in use or in the presence of strong winds, thunderstorms, heavy rain or snow.
- Never place items on top of canopy or exert excessive force onto the frame when in use.
- Always closely supervise children who are in or near the pool at all times.
- Check that all canopy connections are secure prior to entering the pool.
- This product is intended to be used only for the purposes described in the manual.

**FAILURE TO FOLLOW THESE WARNINGS AND THE ASSEMBLY AND USE INSTRUCTIONS MAY RESULT IN SERIOUS INJURY, DROWNING OR PROPERTY DAMAGE.**

©2023 Intex Marketing Ltd. - Intex Development Co. Ltd. - Intex Recreation Corp. All rights reserved/Tous droits réservés/Todos los derechos reservados/Alle Rechte vorbehalten. Printed in China/Imprimé en Chine/Impreso en China/Gedruckt in China.

®™ Trademarks used in some countries of the world under license from/®™ Marques utilisées dans certains pays sous licence de/Marcas registradas utilizadas en algunos países del mundo bajo licencia de/Warenzeichen verwendet in einigen Ländern der Welt in Lizenz von/Intex Marketing Ltd. to/a/a/an Intex Development Co. Ltd., Hong Kong & Intex Recreation Corp., P.O. Box 1440, Long Beach, CA 90801 • Distributed in the European Union by/Distribué dans l'Union Européenne par/Distribuido en la unión Europea por/Vertrieb in der Europäischen Union durch/Intex Trading B.V., Ettenseweg 46, 4706 PB Roosendaal – The Netherlands • Distributed in the UK by Unitex Service (UK) Limited, 21 Holborn Viaduct, London EC1A 2DY, UK. www.intexcorp.com

**INTEX®****SAVE THESE INSTRUCTIONS**

**General:**

- Do not set up the pool on a slope or inclined surfaces. The area where the pool is to be set up must be absolutely flat and level, and at least 2m away from any structure or obstruction such as a fence, garage, house, overhanging branches, laundry lines or electrical wires.
- Do not install the paddling pool on mud, sand, soft or loose soil condition, deck, platform, balcony, concrete, asphalt or any other hard surfaces.
- Do not lean, straddle, or exert pressure on the inflatable wall or side wall as injury or flooding could occur. Do not allow anyone to sit on, climb, or straddle the sides of the pool.
- Protect all pool occupants from recreational water illnesses by keeping the pool water clean. Don't swallow the pool water. Practice good hygiene.
- Remove all hard, sharp and loose objects such as jewelries, watches, buckles, keys, shoes, hairpin, etc from users before entering the pool.
- Pools are subject to wear and deterioration. Properly maintain your pool. Certain types of excessive or accelerated deterioration can lead to pool failure. Pool failure might cause large quantities of water to release from the pool.
- Do not modify this product and/or use accessories not supplied by the manufacturer.
- Choose where you want to install the pool. It's recommended to setup the pool on the west side to block more of the afternoon sun.
- No tools are required for the assembly. Two people are needed to setup this product.
- Make sure the pool is setup and filled with water first.
- Never attempt to setup this product during strong winds, thunderstorms, heavy rain or snow.
- This canopy is designed and manufactured for Intex pool size: 6'x15" (183cm x 38cm).

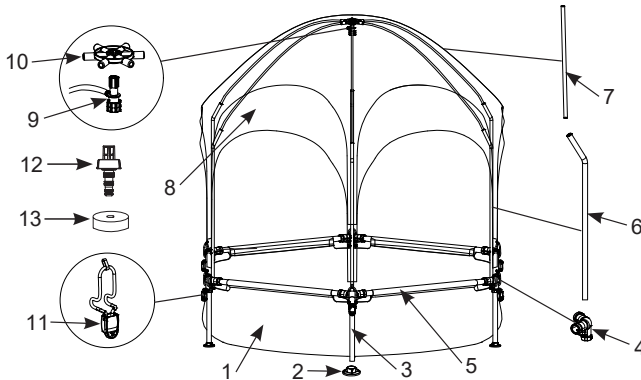
**Parts Reference**

**NOTE:** Drawings for illustration purpose only. May not reflect actual product. Not to scale.

REF. NO.	DESCRIPTION	QTY.	SPARE PART NO.
1	POOL LINER	1	13310
2	LEG CAP	6	11574D
3	VERTICAL LEG	6	13322
4	T-JOINT	6	13323
5	HORIZONTAL BEAM	6	13234
6	J-SHAPED POLE	6	13324
7	CANOPY ROD	6	13325
8	POOL CANOPY	1	13326
9	SPRAYER NOZZLE	1	13327
10	6-WAY CONNECTOR	1	13328
11	ROPE BUCKLE	6	13348
12	DRAIN CONNECTOR	1	10201
13	DRAIN VALVE CAP	1	10649

**SAVE THESE INSTRUCTIONS**

## Setup instructions

### 1. Vertical legs assembly

- Attach a leg cap (2) and a T-joint (4) to the vertical leg (3) (see Fig 1).
- Repeat the process for all the vertical legs.

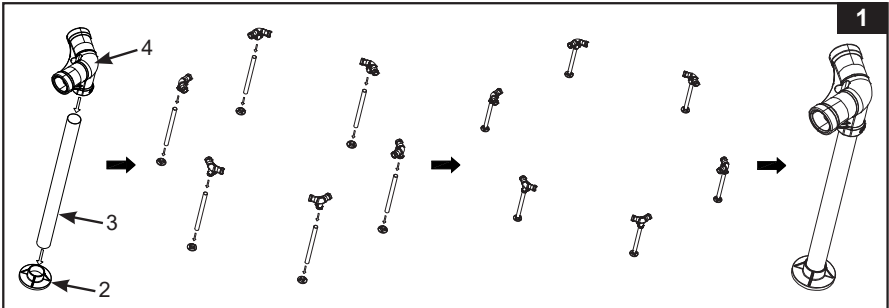

### 2. Horizontal beams assembly

- Take out the liner (1) and spread it out over the ground cloth (not included, available separately), with the drain valve directed towards the draining area. Place the drain valve away from the house. Allow the sun to warm up the liner before inserting the beams (5) into the sleeve openings.
- Starting at any location, but always working in the same direction, insert the horizontal beams (5) into the sleeves (see Fig 2).

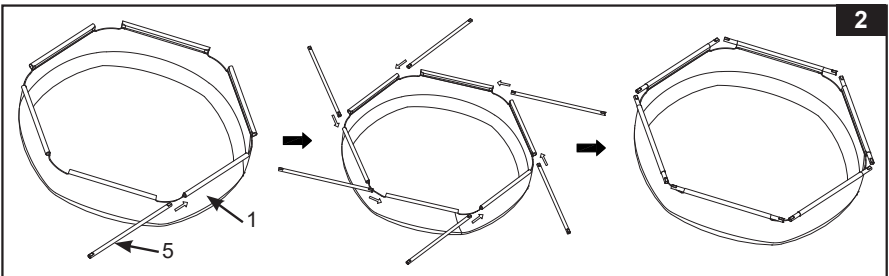

### 3. Pool frame assembly

- Connect the T-joints (4) assembly to the beams (5).
- Repeat this procedure in a circular fashion until all the beams and joints have been connected (see Fig 3).

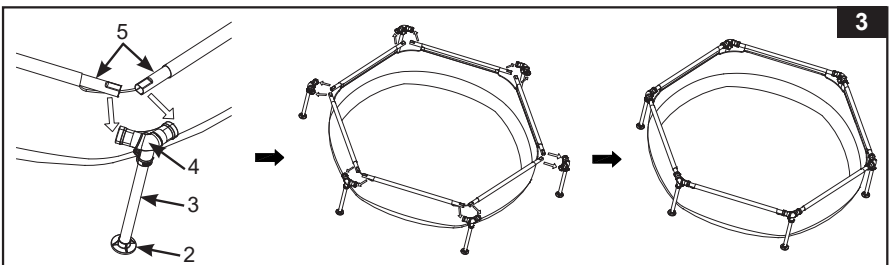

**SAVE THESE INSTRUCTIONS**

#### 4. Sprayer nozzle and 6-way connector assembly

- Insert the sprayer nozzle through the 6-way connector center hole until it stops.  
**NOTE:** the smooth side of the 6-way connector shall face the sprayer nozzle while the side showing the ribs and gaps shall **face up**.
- Hold the sprayer nozzle still and rotate the 6-way connector to the right until it stops and then pull the sprayer nozzle down until it stops (**see Fig 4**). If the 6-way connector does not rotate, remove and flip the 6-way connector with the smooth side facing the nozzle.
- Check that the sprayer nozzle is securely attached to the 6-way connector by pulling the 6-way connector up while pulling the sprayer nozzle down at the same time.

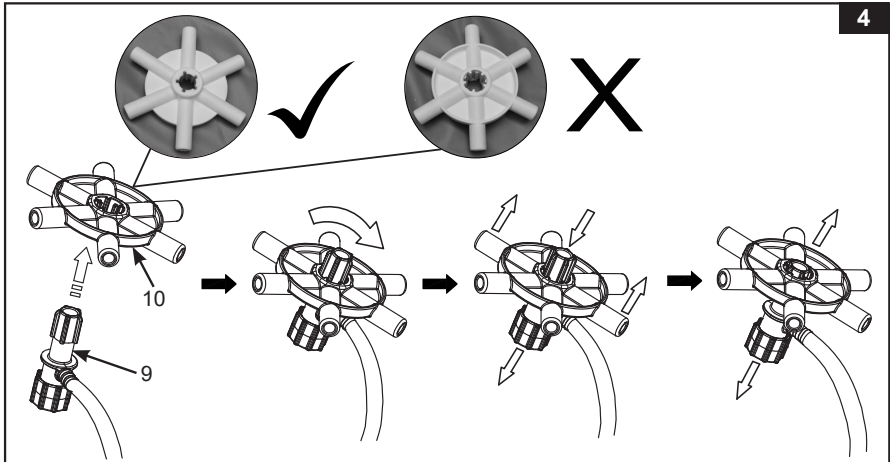

#### 5. Pool canopy assembly

- Spread out the canopy (8) with the loops facing up and place the 6-way connector assembly in the center of the canopy with the sprayer nozzle facing up.
- Insert a canopy rod (7) through the canopy loops and into the 6-way connector (10). Repeat this procedure with all the canopy rods. Make sure the rods are securely inserted into the 6-way connectors.
- Adjust the canopy rods (7) and the 6-way connector (10) so that they are centered on the canopy (**see Fig 5**).

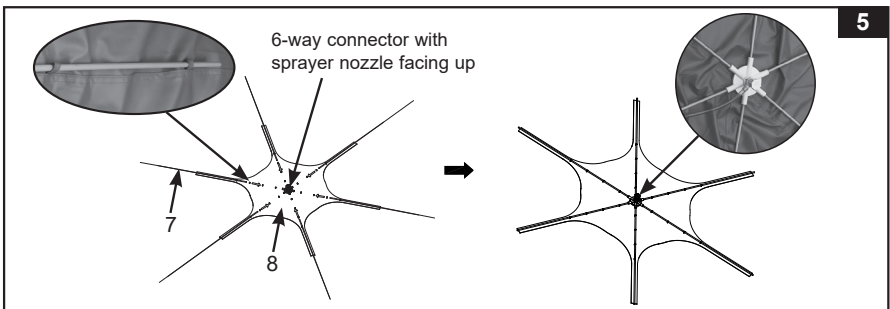

**SAVE THESE INSTRUCTIONS**

## 6. Installing the canopy to the pool

- Insert the J-shaped pole (6) into the hole located on top of the T-joint (4). Repeat the process for all the J-shaped poles (see Fig 6.1 – 6.2).
- Two people are needed to install the assembled canopy onto the J-shaped poles (6). With one person holding one side of the canopy rods, the other person pulls a J-shaped pole (6) out from the T-joint (4), insert the J-shaped pole through the loops on the canopy before connecting the pole to the canopy rod (7). Make sure the J-shaped pole is inserted through the canopy loops first, and the canopy rod (7) is fully inserted into the J-shaped pole (6) before re-inserting the J-shaped pole back into the T-joint. Repeat this process for all the J-shaped poles (see Fig 6.3 – 6.6).
- Route the canopy ropes through the protruding hooks located on each side of the T-joint (4). Make sure the ropes are securely hooked to the T-joint, then open the rope buckle (11), pull the buckle up to tighten up the canopy, and close the buckle to lock the rope in place. Repeat the process with all the canopy ropes and buckles (see Fig 6.7 – 6.10).
- Connect the other end of the sprayer nozzle hose to a garden hose. Once the hose is connected, gradually open the tap water. Rotate the sprayer nozzle rim left or right to adjust the water sprayer performance. **NOTE:** route the sprayer hose together with one of the J-shape pole.

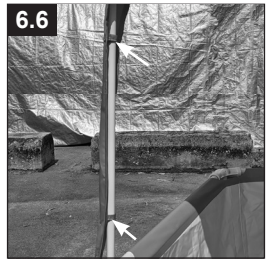
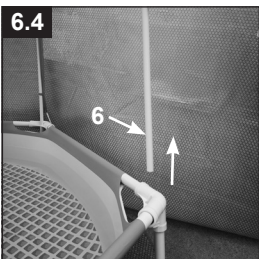
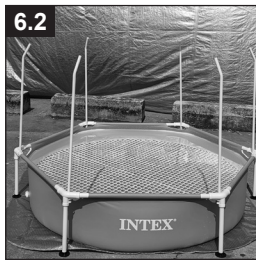
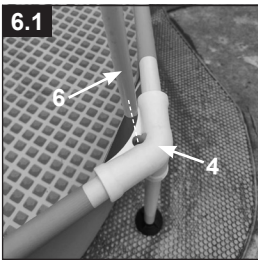

**SAVE THESE INSTRUCTIONS**

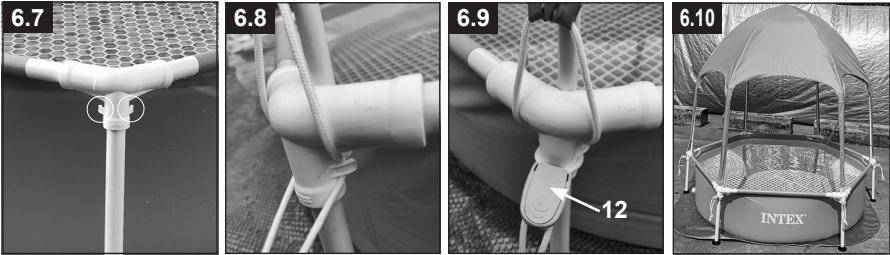

### Maintenance and long term storage

1. Regularly check all components for sign of damage and straining. Replace damaged components immediately.
2. Use a sponge and clean water to wipe away any soil or stains on the canopy.

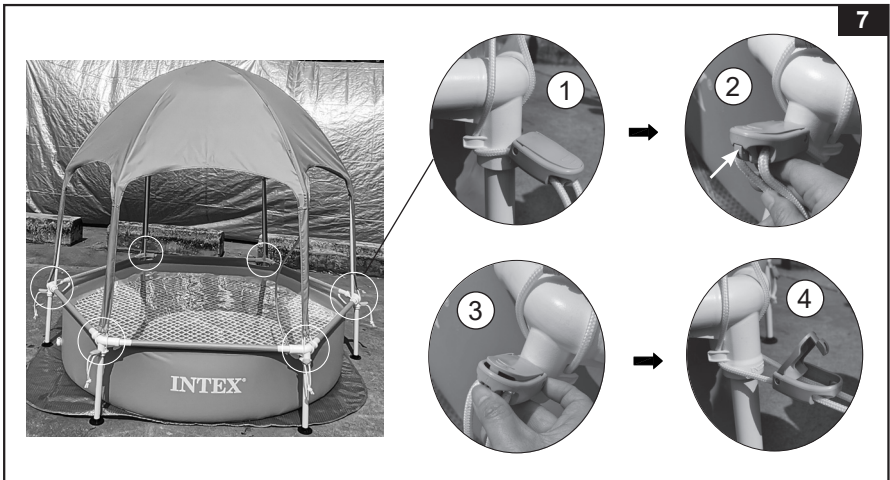

3. Two people are needed for disassembly. Remove the canopy assembly from the frame pool (see Fig 7).
4. Reverse the above setup instructions, and make sure all components are completely dry before storage.
5. Air dry the liner, canopy and accessories in the sun until completely dry before folding.
6. Store the canopy, pool and accessories in a dry, temperature controlled, between 0° – 40°C (32° – 104°F), storage location.
7. The original packing can be used for storage.

**SAVE THESE INSTRUCTIONS**

## Limited Warranty

183  
IO

Your Intex Metal Frame Pool with Canopy has been manufactured using the highest quality materials and workmanship. All Intex products have been inspected and found free of defects prior to leaving the factory. This Limited Warranty applies to the Intex Metal Frame Pool with Canopy only.

This limited warranty is in addition to, and not a substitute for, your legal rights and remedies. To the extent that this warranty is inconsistent with any of your legal rights, they take priority. For example, consumer laws across the European Union provide statutory warranty rights in addition to the coverage you receive from this limited warranty: for information on EU-wide consumer laws, please visit the European Consumer Center website at [http://ec.europa.eu/consumers/ecc/contact\\_en/htm](http://ec.europa.eu/consumers/ecc/contact_en/htm).

The provisions of this Limited Warranty apply only to the original purchaser and are not transferable. This Limited Warranty is valid for the period noted below from the date of the initial retail purchase. Keep your original sales receipt with this document, as proof of purchase will be required and must accompany warranty claims or the Limited Warranty will be invalid.

### Metal Frame Pool with Canopy Warranty - 180 days

If you find a manufacturing defect in the Intex Metal Frame Pool with Canopy during the warranty period, please contact the appropriate Intex Service Center listed in the separate "Authorized Service Centers" sheet. If the item is returned as directed by the Intex Service Center, the Service Center will inspect the item and determine the validity of the claim. If the item is covered by the provisions of the warranty, the item will be repaired or replaced, with the same or comparable item (at Intex's choice) at no charge to you.

Other than this warranty, and other legal rights in your country, no further warranties are implied. To the extent possibly in your country, in no event shall Intex be liable to you or any third party for direct or consequential damages arising out of the use of your Intex Metal Frame Pool with Canopy, or Intex or its agents' and employees' actions (including the manufacture of the product). If your country does not allow the exclusion or limitation of incidental or consequential damages, this limitation or exclusion does not apply to you.

You should note that this limited warranty does not apply in the following circumstances:

- If the Intex Metal Frame Pool with Canopy is subject to negligence, abnormal use or application, accident, improper operation, improper maintenance or storage.
- If the Intex Metal Frame Pool with Canopy is subject to damage by circumstances beyond Intex's control, including but not limited to, punctures, tears, abrasions, ordinary wear and tear and damage caused by exposure to fire, flood, freezing, rain, or other external environmental forces;
- To parts and components not sold by Intex; and/or
- To unauthorized alterations, repairs or disassembly to the Intex Metal Frame Pool with Canopy by anyone other than Intex Service Center personnel.

The costs associated with the loss of pool water, chemicals or water damages are not covered by this warranty. Injury or damage to any property or person is not covered by this warranty.

Read the owner's manual carefully and follow all instructions regarding proper operation and maintenance of your Intex Metal Frame Pool with Canopy. Always inspect your product prior to use. This limited warranty will be void if use instructions are not followed.

**SAVE THESE INSTRUCTIONS**