

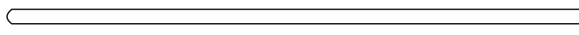

PRODUCENT:  
MULTISTORE ECOTOYS Krystian Ślebioda  
Sady, Logistyczna 31, 62-080 Tarnowo Podgórne

### Components/elementy:



Tube/ Rura A x4

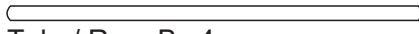

Tube/ Rura B x4



Tube/ Rura PE-A x4

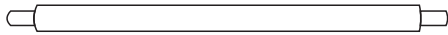

Tube/ Rura PE-B x4

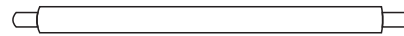

Tube/ Rura PE-C x4



T-Joint x8  
Złącze typu T



Upper Corner Joint x4  
Górny narożnik



Bottom Corner Joint x4  
Dolny narożnik



Baby Playpen Cloth x1  
Pokrowiec kojca

### Installation/montaż:

1. Open the baby playpen cloth
1. Rozłóż pokrowiec kojca

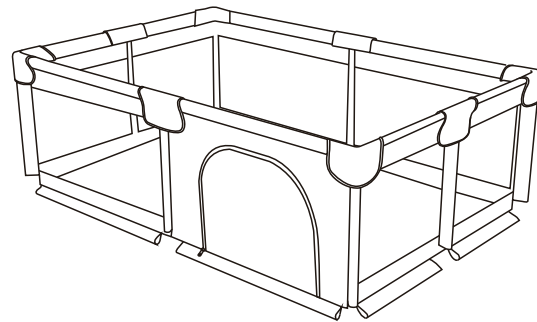
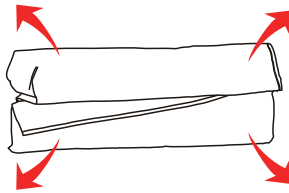

2. Assembly diagram
2. Schemat montażu

①



Baby Playpen Cloth/ Pokrowiec kojca

②



Tube/rura A

③



Tube/rura B

④

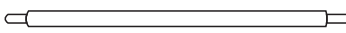

Tube/rura PE-A

⑤

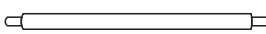

Tube/rura PE-B

⑥

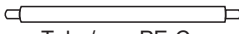

Tube/rura PE-C

⑦



T-Joint – Złącze typu T

⑧



Upper Corner Joint – Górny narożnik

⑨



Bottom Corner Joint – Dolny narożnik

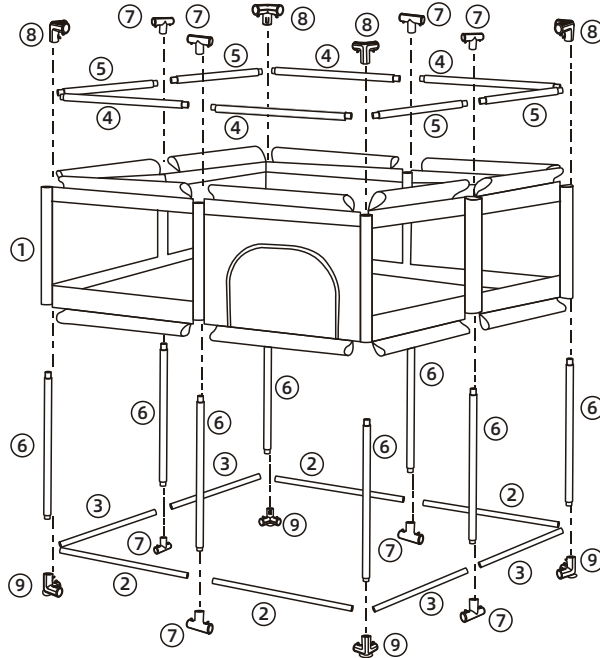

3. Connect all components, complete assembly
3. Połącz wszystkie elementy, zakończ montaż

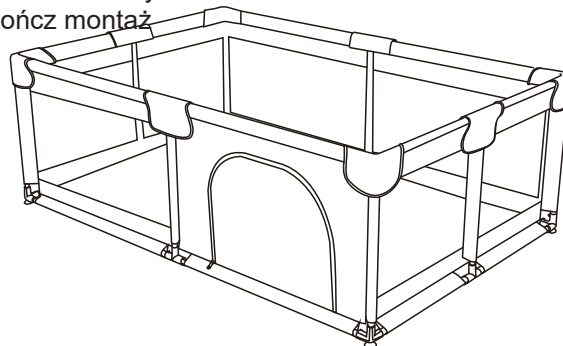

Disassembly Instructions/Instrukcja demontażu

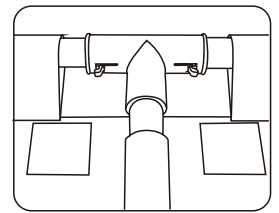
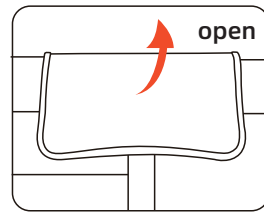
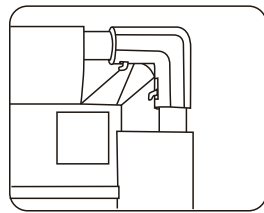
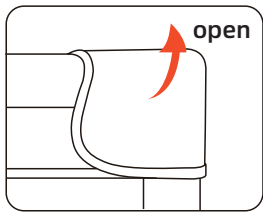

Open all protect fabric cover/Otwórz wszystkie osłony materiałowe

Top/Góra

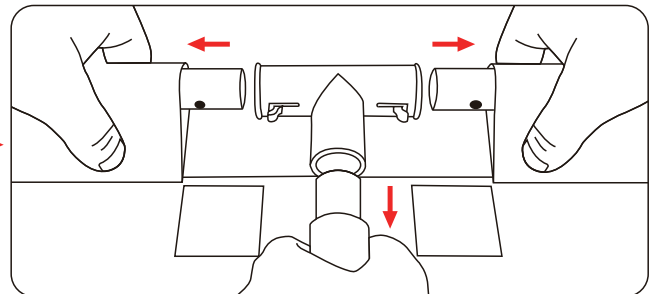
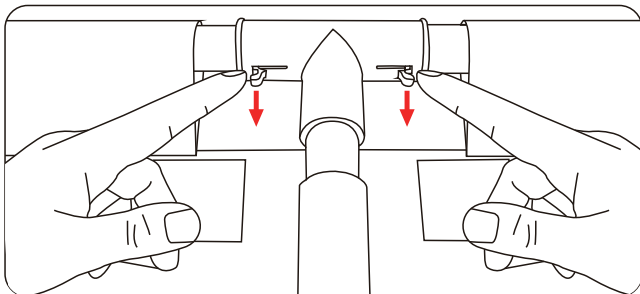
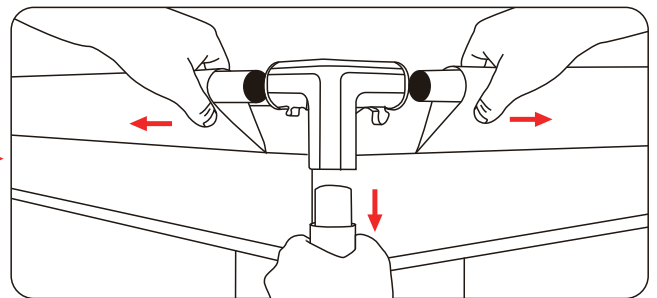
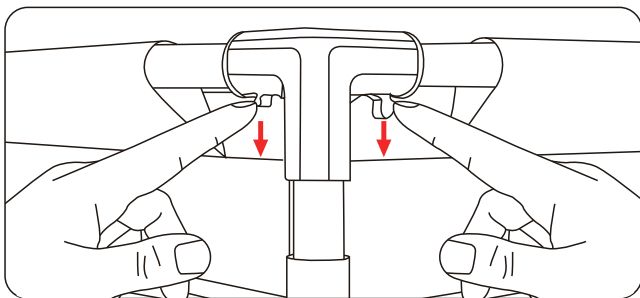

Bottom/Dół

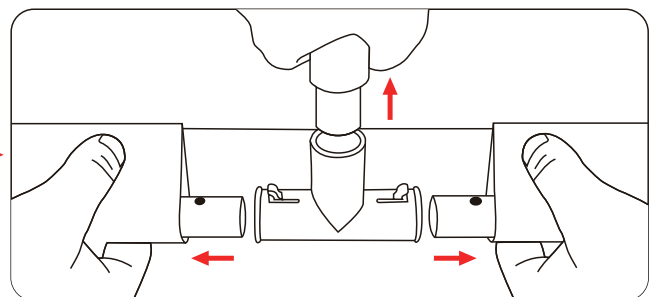
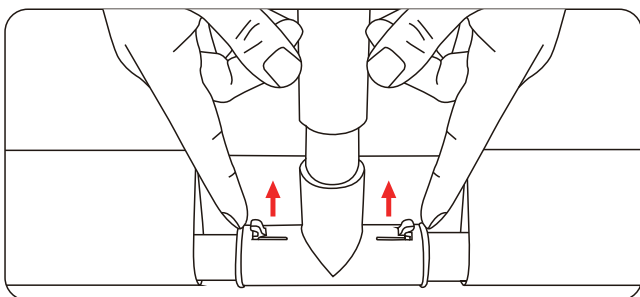
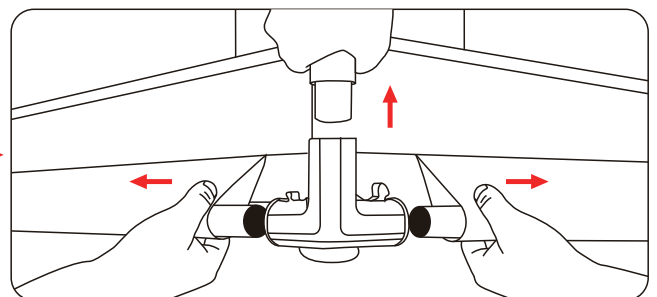
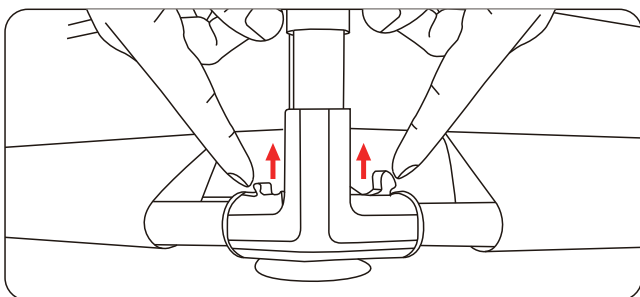

Release the latches to put out the stainless steel tube/Zwolnij zatrask, aby wyjąć rurkę ze stali nierdzewnej